

Area: Sectors
Video 46 on www.corbettmaths.com

Examples



Workout

Click here

Scan here

Question 1: Calculate the area of each of the following sectors.
Give each answer to one decimal place and include units.

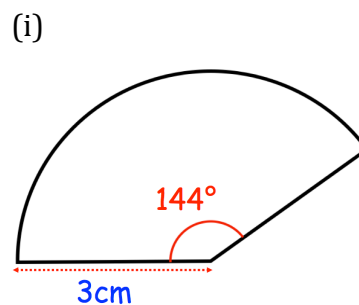
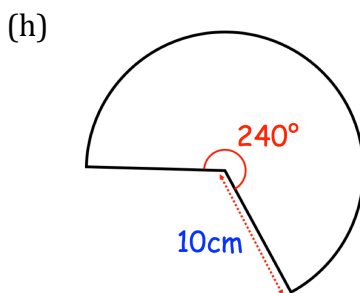
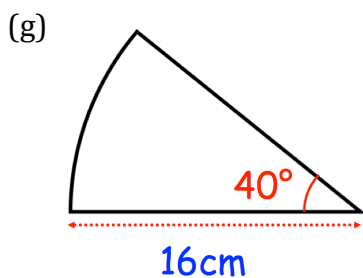
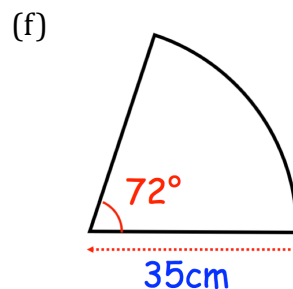
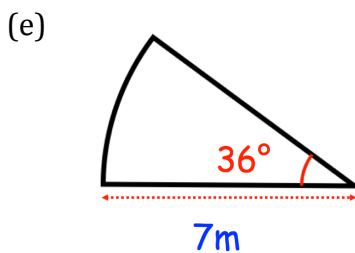
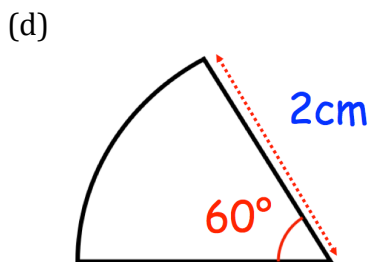
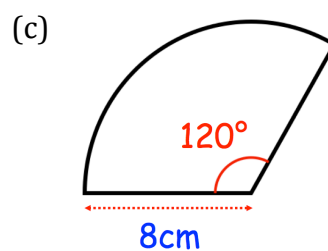
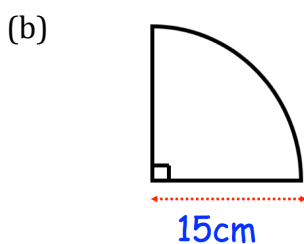
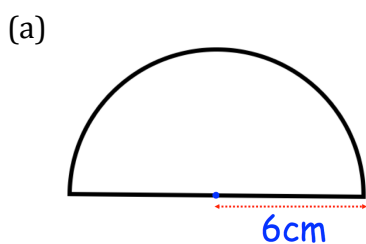

Question 2: Calculate the area of each of these sectors.
Give each answer to 2 decimal places and include suitable units.

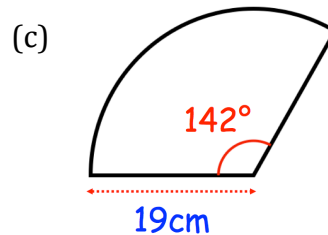
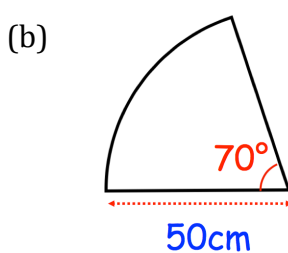
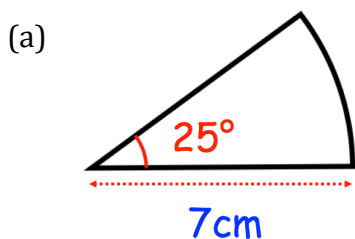

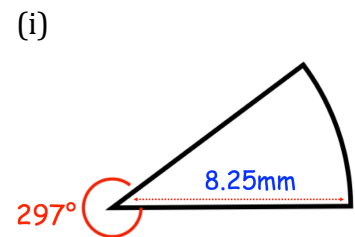
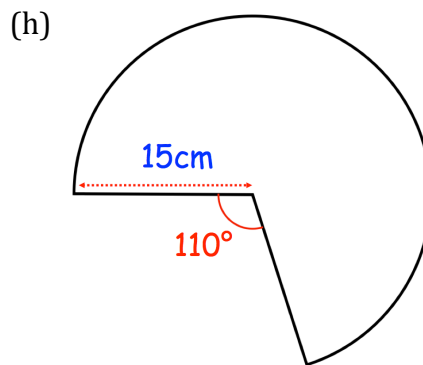
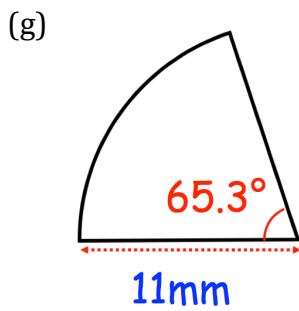
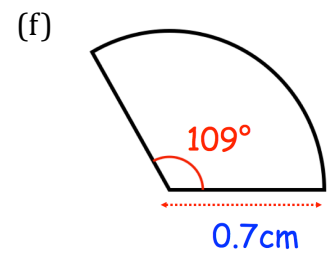
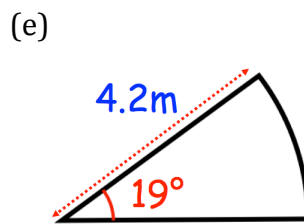
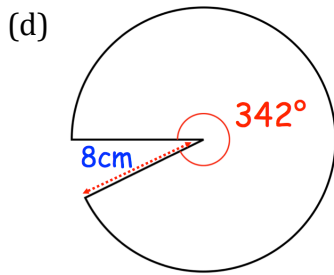

Question 3: Find the area of these sectors.
Leave your answer in terms of π

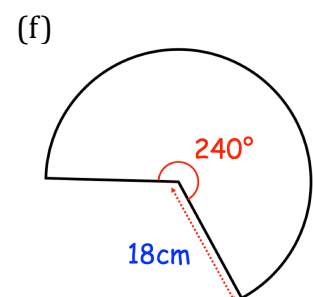
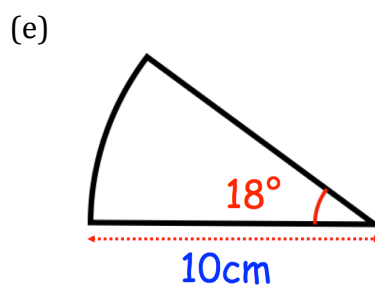
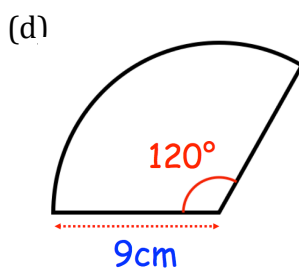
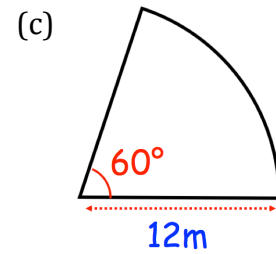
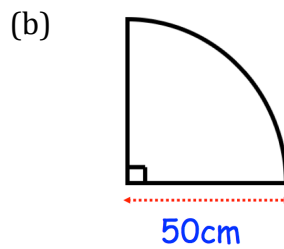
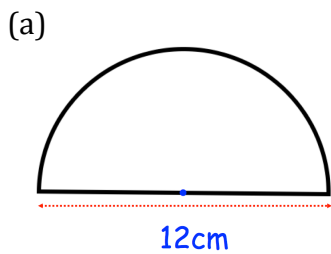

Question 4: The areas of these sectors have been given.
Calculate x .

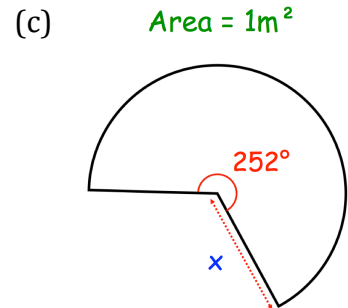
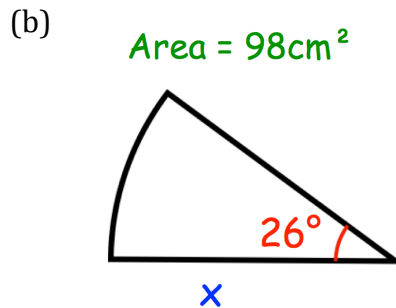
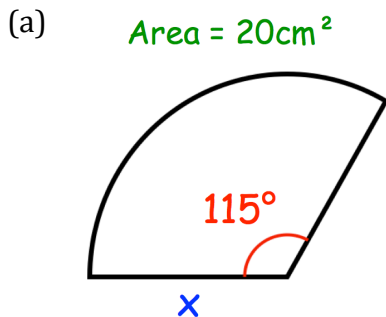

Question 5: The areas of these sectors have been given.
Calculate the missing angles.

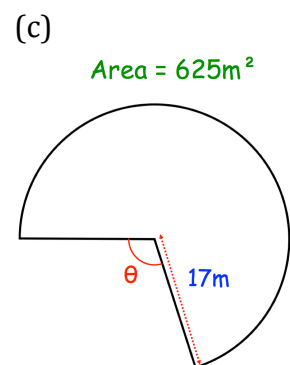
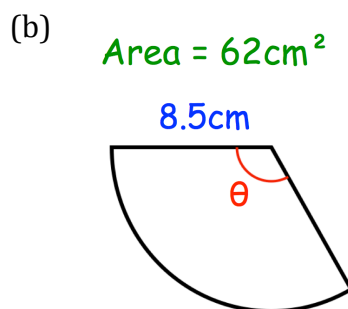
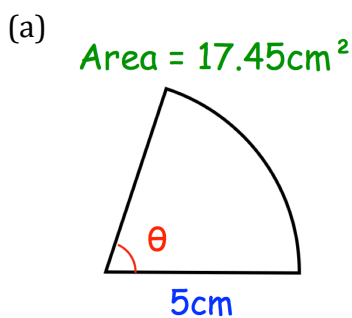

Question 6: The areas these sectors have been given in terms of π .
Work out x

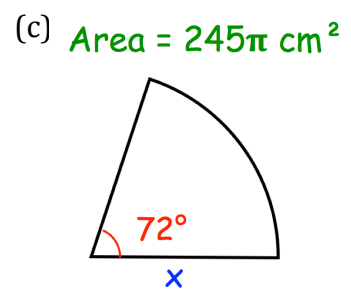
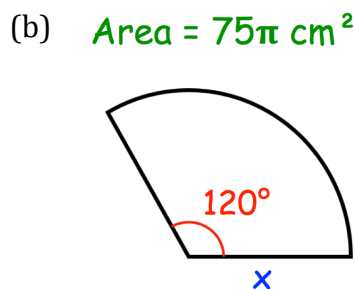
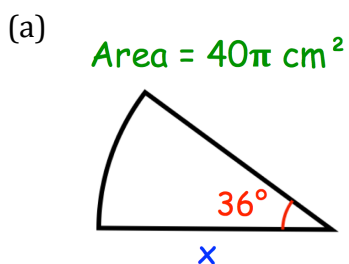

Apply

Question 1: The perimeter of the sector below is 103cm
Find the area of the sector

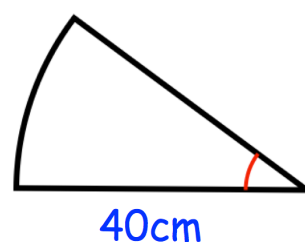

Area: Sectors
Video 46 on www.corbettmaths.com

Question 2: These two sectors have the same area.
James says x is 2cm.
Is he correct?

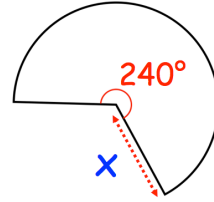
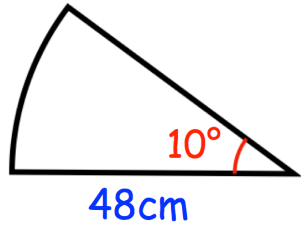

Answers



Click here



Scan here